

寸法

■ 公道走行状態

単位(mm)

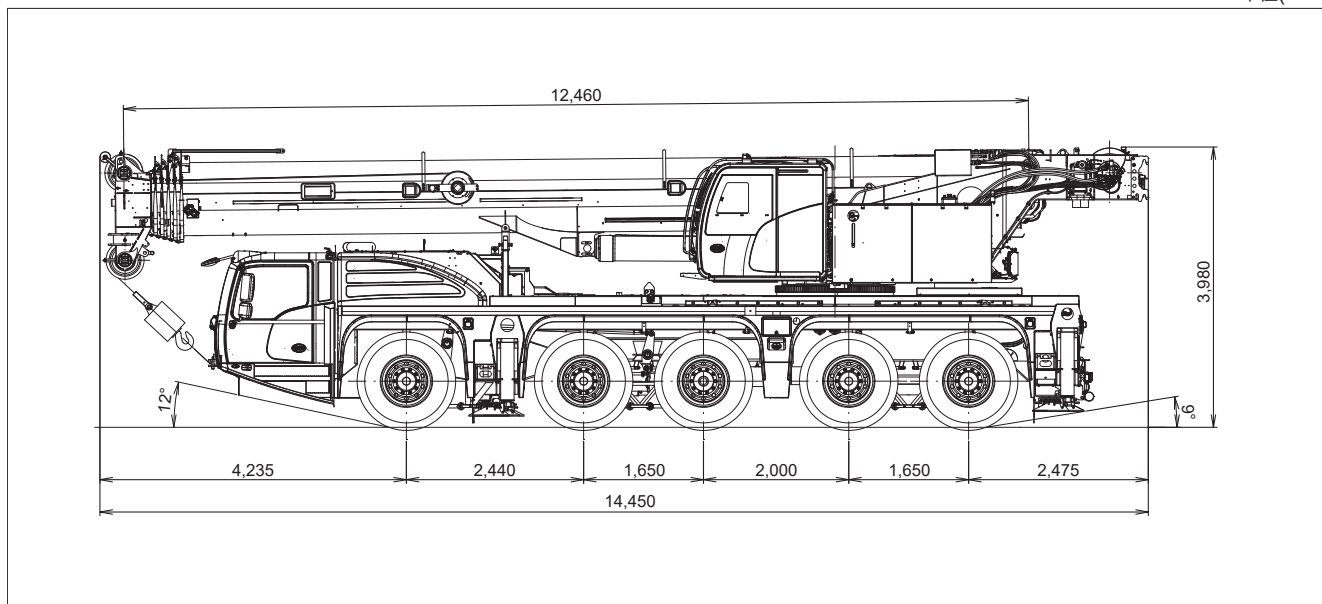

■ アウトリガ張出幅・テールスイング

単位(mm)

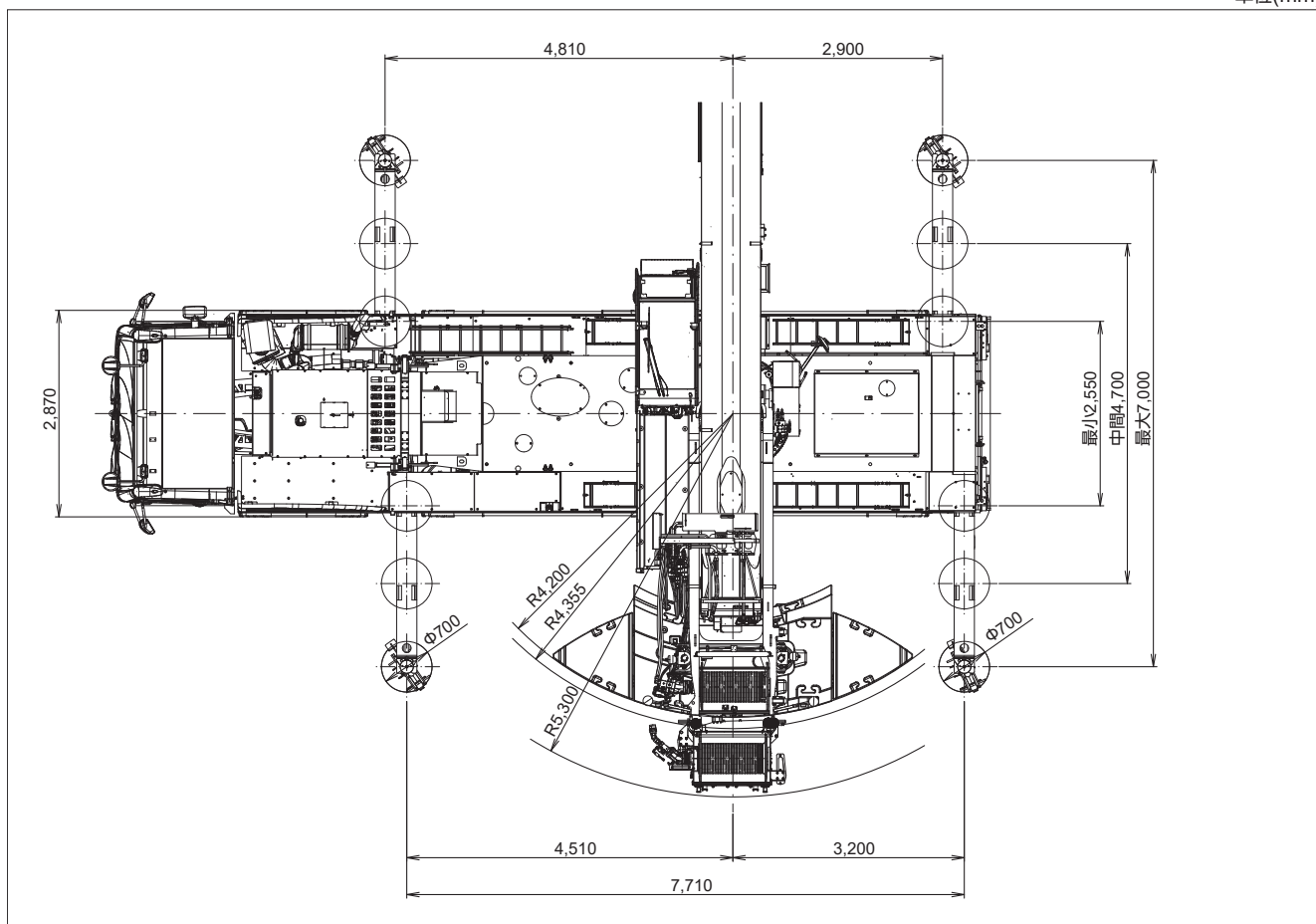

寸法

■ 最小直角通路幅

単位(mm)

● 公道走行状態・構内移動姿勢

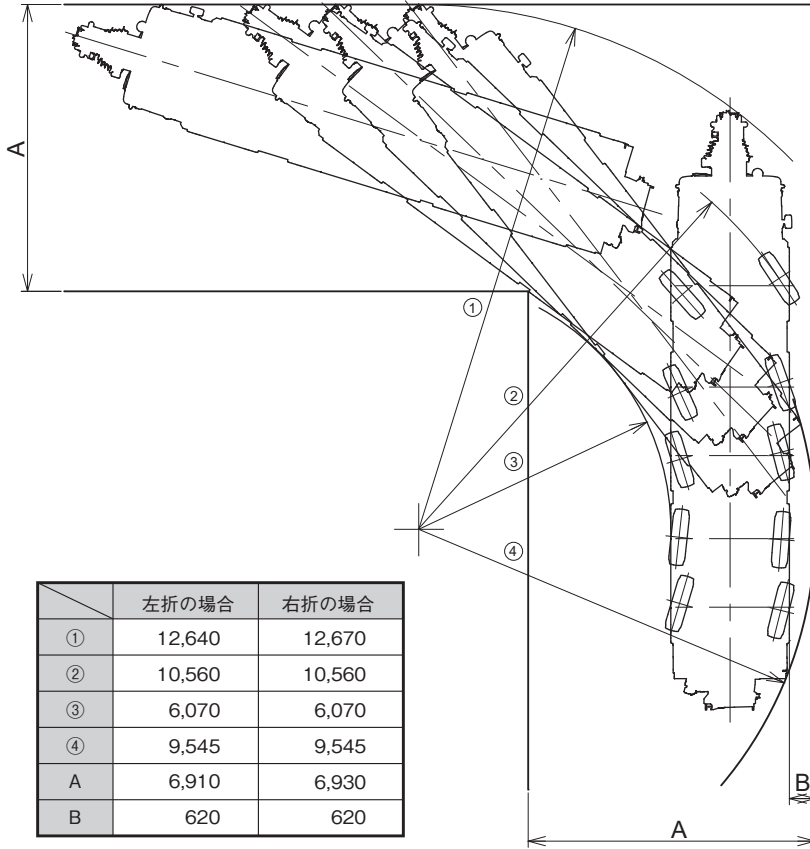

	左折の場合	右折の場合
①	12,640	12,670
②	10,560	10,560
③	6,070	6,070
④	9,545	9,545
A	6,910	6,930
B	620	620

主要諸元 (技術データ)







車両総重量 (公道走行状態)	
全重量	48,150 kg ^(※1)
前軸	20,750 kg ^(※1) (1軸+2軸)
後軸	27,400 kg ^(※1) (3軸+4軸+5軸)

※1) 仕様書記載の重量は参考値となります。
正確な値は車検証に記載の重量を確認してください。

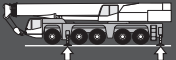







* 手動で作動









	63 t	73 t	80 km/h
	530 mm	610 mm	
	385/95 R 25 14.00 R 25		
	47 %		
	64 %		



				
1	120 m ³ /min ^(※2)	82.4 kN	21 mm	300 m
2	120 m ³ /min ^(※2)	82.4 kN	21 mm	330 m
	1.70 min ⁻¹ ^(※2)			
	438 s ^(※2) (12.5 - 59.8 m)			
	35 s ^(※2) (-1.5° - 82°)			

※2) 上記の作動速度は計算値です。

					
1	8.3	12.5-0/21	4	350 kg	2.00 m
2	16.6	32-1/21	4	630 kg	2.70 m
3	24.7	32-1/21	4	630 kg	3.00 m
4	32.8	80-3/21	4	850 kg	3.00 m
5	40.8	80-3/21	4	850 kg	3.00 m
6	48.7	80-3/21	4	850 kg	3.00 m
7	56.5	80-3/21	4	850 kg	3.00 m
8	64.3	160-7/21	4	1,660 kg	3.00 m
9	72.0	160-7/21	4+2	1,660 kg	3.00 m
10	79.6	160-7/21	4+2	1,660 kg	3.00 m
11	87.1	160-7/21	4+2	1,660 kg	3.00 m
12	91.8	160-7/21	4+2	1,660 kg	3.00 m

カウンタウエイト

部品 単位(mm)

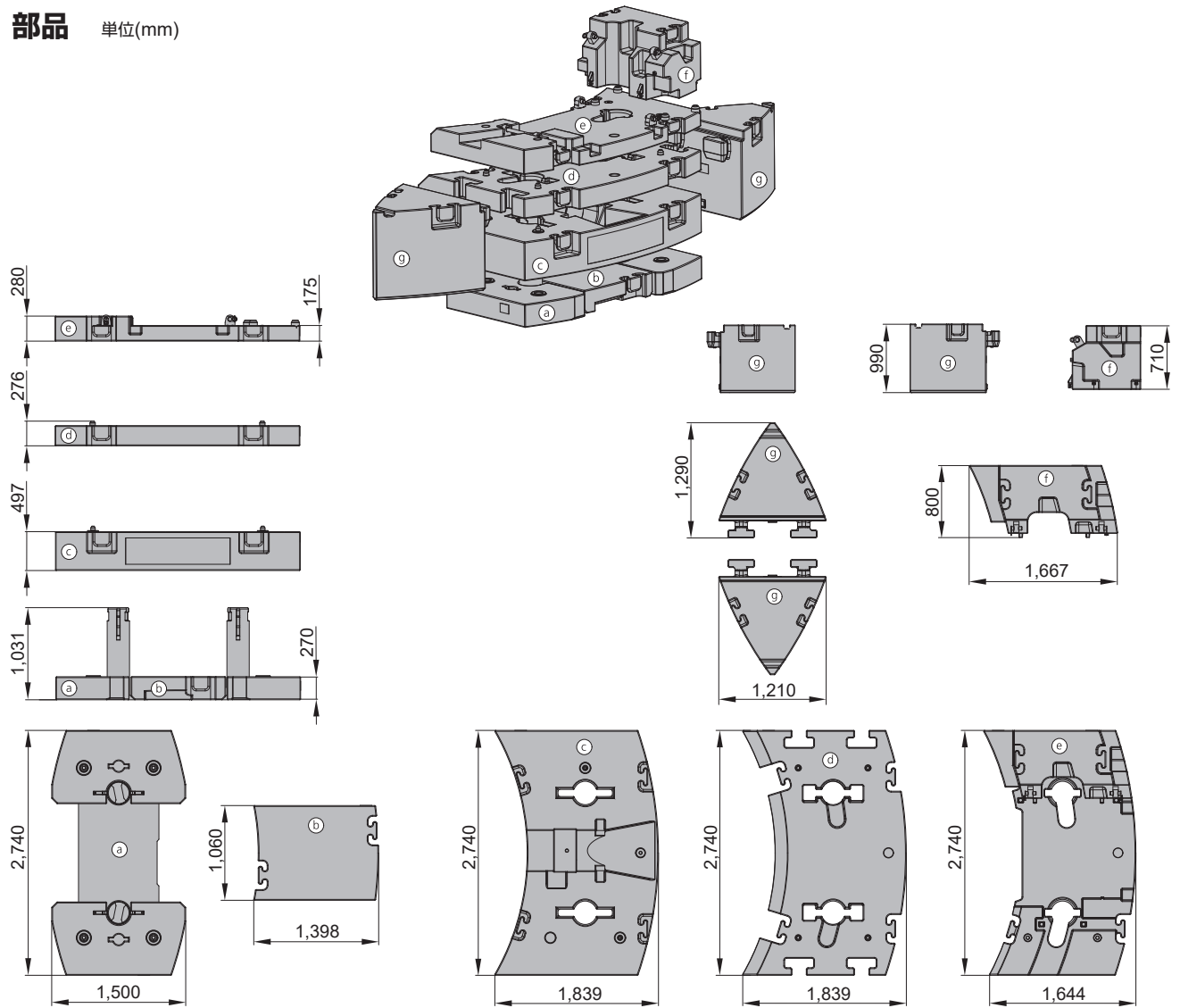





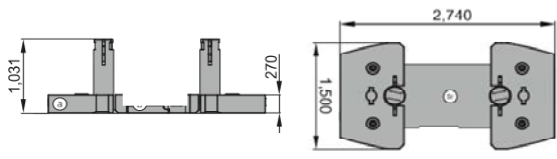
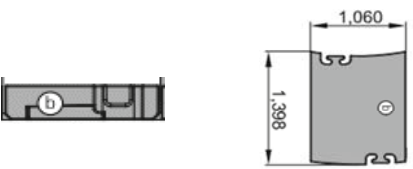
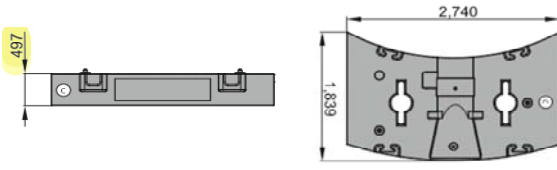
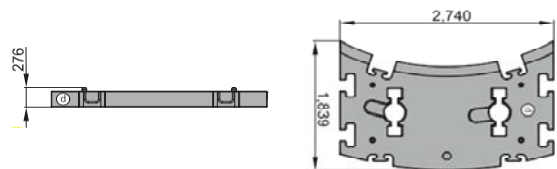
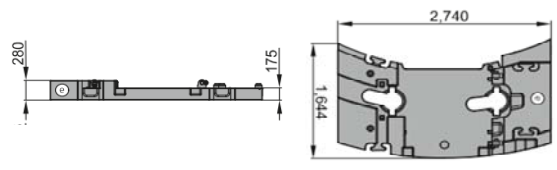
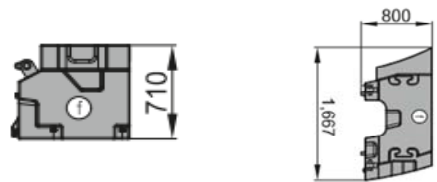
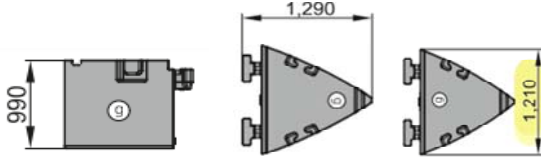
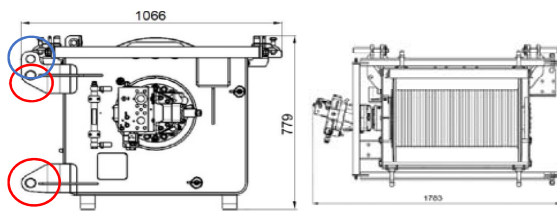

構成

	Ⓐ 4.9 t	Ⓑ 2.1 t	Ⓒ 11.0 t	Ⓓ 5.4 t	Ⓔ 4.5 t	Ⓕ 3.7 t	Ⓖ 5.3 t	Ⓗ 5.3 t
0 t								
3.7 t						X		
4.9 t	X							
7.0 t	X	X						
8.6 t	X					X		
10.7 t	X	X				X		
13.1 t	X				X	X		
15.2 t	X	X			X	X		
18.0 t	X	X	X					
21.7 t	X	X	X			X		
23.4 t	X	X	X	X				
27.1 t	X	X	X	X		X		
27.9 t	X	X	X	X	X			
31.6 t	X	X	X	X	X	X		
38.5 t	X	X	X	X	X		X	X
42.2 t	X	X	X	X	X	X	X	X

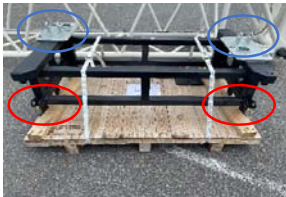
■ 分解搬送部品

No.	名称	外観寸法	個数	質量
1	カウンタウエイト ①4.9t		1	4.9t
2	カウンタウエイト ②2.1t		1	2.1t
3	カウンタウエイト ③11.0t		1	11.0t
4	カウンタウエイト ④5.4t		1	5.4t
5	カウンタウエイト ⑤4.5t		1	4.5t
6	カウンタウエイト ⑥3.7t		1	3.7t
7	カウンタウエイト ⑦5.3t		2	5.3t
8	補巻ウインチ		1	1.7t

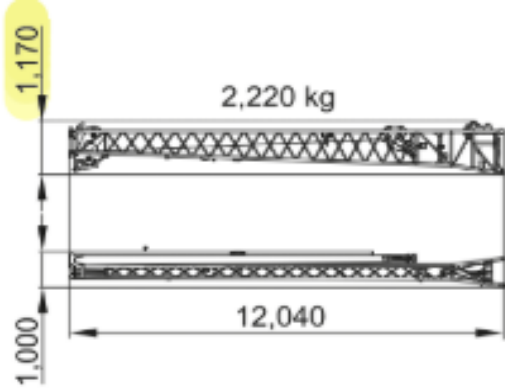
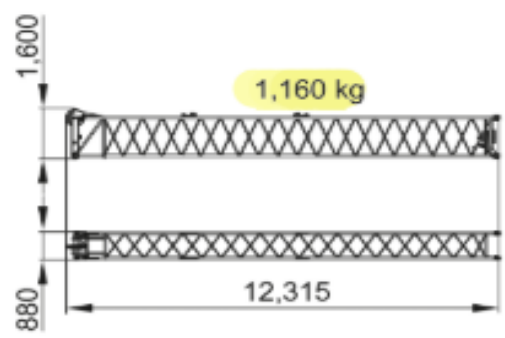
■ 分解搬送部品

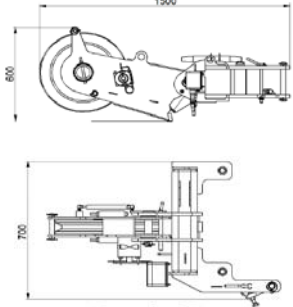
9	補巻ウインチ 自力着脱サポート	 (1630 × 930 × 512)	1	0.23t
10	91.8tフック	 (1750 × 625 × 622)	1	1.66t
11	56.5tフック	 (1540 × 625 × 362)	1	0.85t
12	24.7tフック	 (1500 × 625 × 255)	1	0.63t
13	油圧チルトジブ (トップ+ベース)		1	2.22t
14	ミドルジブ		1	1.16t
15	ジブ用ホースリール	 φ 1400 × 476	1	0.2t
16	シングルトップ		1	0.16t

■分解搬送部品

17	ブームアタッチメントシーブ	 <p>(1165 × 607 × 219)</p>	2	0.11t/個
----	---------------	---	---	---------